

異形 甲

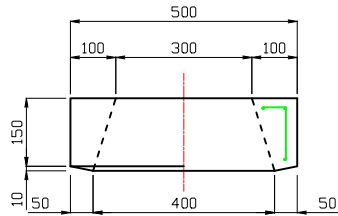

側塊 H=200

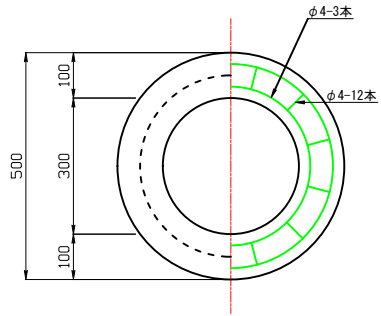
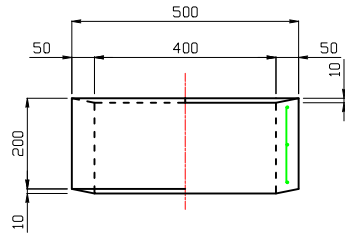
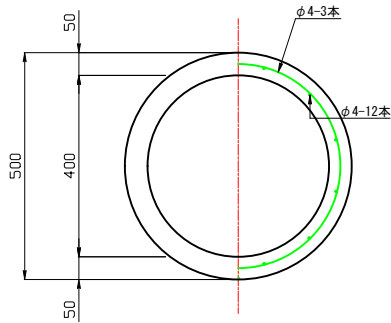

側塊 H=500

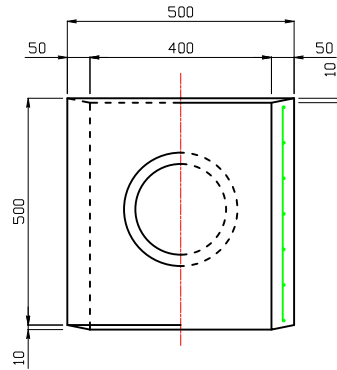
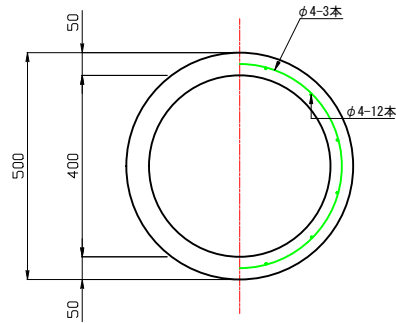

底塊

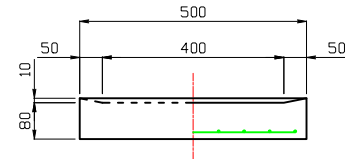
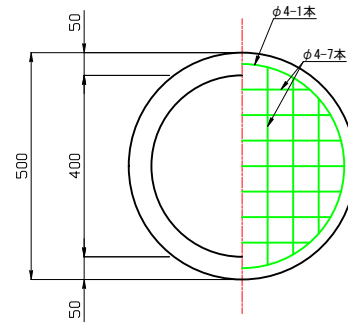

製品名	L形用集水樹 (300用)		
図面番号	担当	尺度	
		1:10	
豊国コンクリート工業株式会社			